

PRODUCT CODE: IT2B
CONDUIT INSPECTION TEE



DESCRIPTION

25mm Conduit Inspection Tee

FINISH

Black Enamel

MATERIAL

Body: Malleable Iron / Cover: Steel

PACKAGING

Packed in qty 10

ADDITIONAL NOTES

Conforms to BS EN61386-1
Compliant to LU Standard 1-085 (for use on surface & sub-surface locations)
Supplied complete with qty 2 M4 x 6mm pozi-pan screws

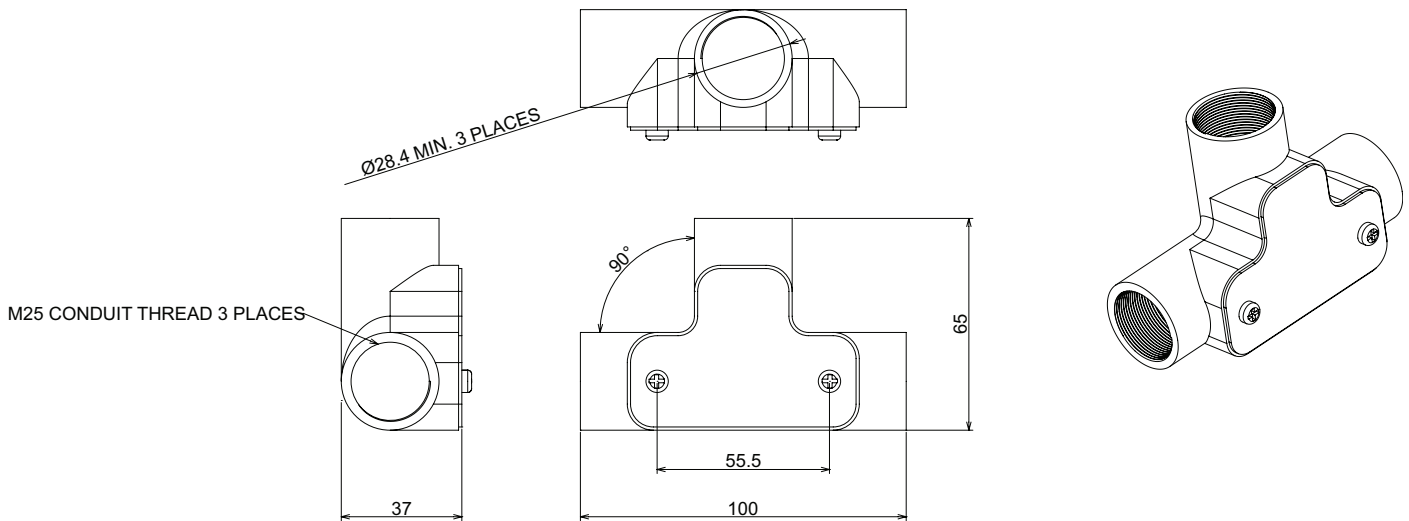

Values are nominal and with a general tolerance $\pm 5\%$ unless otherwise specified